

University of Illinois at Urbana-Champaign  
Dept. of Electrical and Computer Engineering

## ECE 120: Introduction to Computing

### Example of Serialization

## Review of General Bit-Slice Model

### General model parameters

**N-bit** operands

**P** bits of input from operands

**Q** bits of output produced

**M** bits between bit slices

**R** bits of final output (not shown; produced by output logic operating on **M** bits from last bit slice).

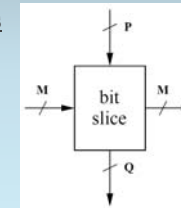

## Parameter Values for a Serial Comparator

### Comparator parameters

**N-bit** operands

**P = 2**

**Q = 0**

**M = 2**

**R = 2**

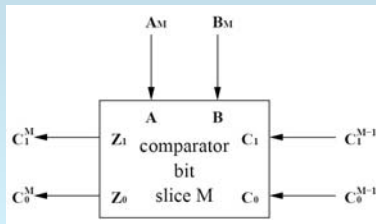

## Initialization of a Serial Comparator

Our comparator bit slice uses the representation shown here to pass information between slices.

**What values should be passed to the first bit slice?**

**A = B, so  $C_1 C_0 = 00$**

$C_1$	$C_0$	meaning
0	0	<b>A = B</b>
0	1	<b>A &lt; B</b>
1	0	<b>A &gt; B</b>
1	1	not used

### Example: A Serial Comparator

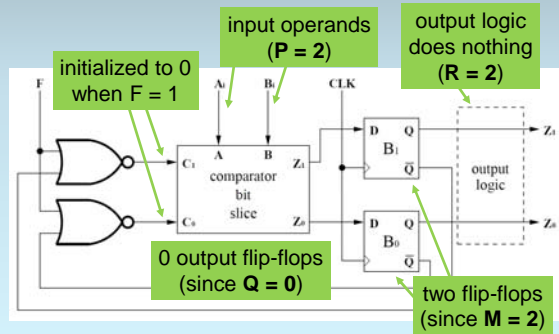

### Discrete Time Implies Delayed Results: N = 4

yellow = inputs (green = bit slice labels)

cycle #	F	A	B	B <sub>1</sub>	B <sub>0</sub>	C <sub>1</sub>	C <sub>0</sub>	Z <sub>1</sub>	Z <sub>0</sub>
0	1	0	1	bits	bits	0	0	0	1
1	0	1	1	0	1	0	1	0	1
2	0	1	0	0	1	0	1	1	0
3	0	0	1	1	0	1	0	0	1
4	x	x	x	0	1	0	?	?	?

blue = outputs

### A Serial Comparator Consists of Three Parts

Let's analyze the area of a serial comparator.

We have:

- one bit slice,
- two flip-flops, and
- two 2-input NOR gates (selection logic).

### A Serial Comparator Contains One Bit Slice

Assume the smaller version of the bit slice. So we need **six 2-input NAND gates** and **two inverters**.

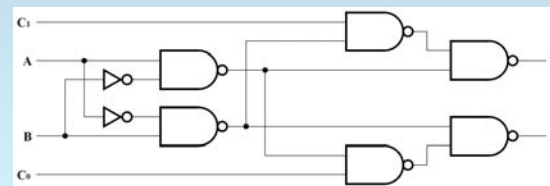

## A Serial Comparator Consists of Three Parts

Let's analyze the area of a serial comparator.

We have:

- one bit slice, **six 2-input NAND and two inverters**
- two flip-flops, and
- two 2-input NOR gates (selection logic).

## A Serial Comparator Uses Two Flip-Flops

A flip-flop is two latches and an inverter.

If we use NOR gates for the first latch, we don't need the extra inverter.\*

So **eight 2-input gates** and **two inverters** (each).

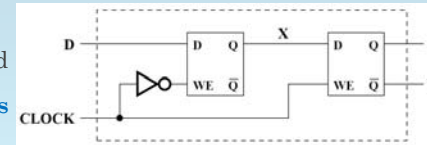

\*And real designs, optimized at the transistor level, are even smaller.

## A Serial Comparator Consists of Three Parts

Let's analyze the area of a serial comparator.

We have:

- one bit slice, **six 2-input NAND and two inverters**
- two flip-flops, and
- two 2-input NOR gates (selection logic). **16 2-input gates and four inverters**

Total:  $6+16+2 = 24$  2-input gates and  
 $2+4 = 6$  inverters.

## Serial Design is Smaller for $N \geq 4$

To handle **N-bit** operands, a bit-sliced design requires:

- **$6N$  2-input gates**, and
- **$2N$  inverters**.

A serial design (independent of **N**) requires

- **24 2-input gates**, and
- **6 inverters**.

**The serial design is smaller for  $N \geq 4$ .**

## Serial Designs are Slower than Bit-Sliced Designs

The tradeoff? Serial designs are **slower** than bit-sliced designs.

### Why?

There are three reasons:

1. All paths matter.
2. Selection logic and flip-flops add to delay.
3. Other logic may further reduce the speed of the common clock.

Let's look at each in more detail.

## All Paths Matter in a Serial Design

In an **N-bit bit-sliced design**,

- All external inputs appear at time 0,
- So only the **slice-to-slice paths** in the bit slice **contribute to the multiplier on N**.
- **Other paths contribute only constant time** to the overall delay in the design.

In a **serial design**, all paths matter.

- All input bits arrive in the cycle in which they are consumed, so
- **long paths from any input can slow down the design** overall.

## Flip-Flops and Selection Logic Add to Delay

Flip-flops take time

- To store values,
- To produce values.

And the selection logic sits between the flip-flops and the bit-slice inputs.

The clock cycle

- must be long enough
- to account for all of these delays.

## Clock Speed is Determined by the Slowest Logic

The longest path through combinational logic determines the speed of the common clock.

In practice,

- engineers identify complex and/or important elements and
- work hard to make them fast or
- to split them into several cycles.

Even if a serial design's logic needs only 0.1 clock cycles, operating on **N-bit** operands still takes **N** clock cycles.

### Assume Four Gate Delays On Either Side of Clock Edge

Let's analyze the delay of a serial comparator.

We can count gate delays

- in the bit slice, and
- for the selection logic.

#### What about the flip-flops?

Let's assume

- **four gate delays** of stable D input needed **before the rising edge**, and
- **four gate delays** after the rising edge.

### When Are Inputs Available?

A rising edge arrives at  $t = 0$  (gate delays).

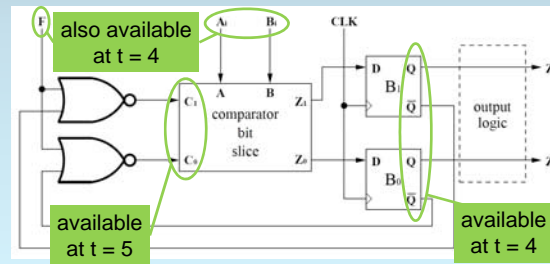

### Delay Analysis for the Bit Slice

**A to  $Z_1$ : 3 gate delays (ignoring NOT)**

**$C_1$  to  $Z_1$ : 2 gate delays** Paid 4 gate delays for flip-flops.

**B to  $Z_1$ : 3 gate delays**

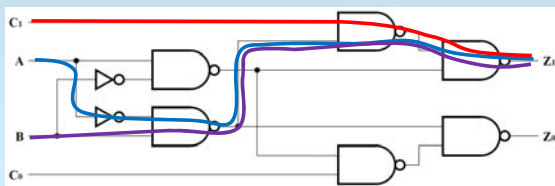

### When Are Results Stored?

A rising edge arrives at  $t = 0$  (gate delays).

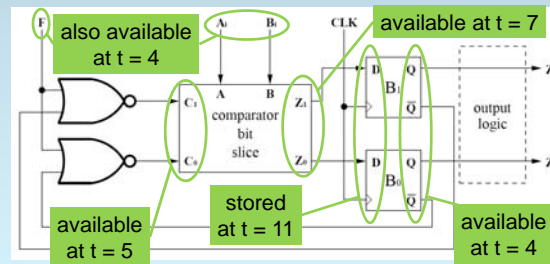

## Serial Design is At Least 5.5x Slower

To handle **N-bit** operands, a bit-sliced design requires  **$2N + 1$  gate delays**.

For a serial design,

- the clock cycle must be **at least 11 gate delays**, and
- we must execute for **N** cycles, so
- **N-bit** operands require **at least 11N gate delays**.

**The serial design is at least 5.5x slower.**

(And may be even slower!)

## Bit-Sliced and Serial Designs are Extrema

Both designs are **simple**.

Serial designs are relatively **small, but slow**.

Bit-sliced designs are **fast, but large**.

But we **can build anything in between**:

- 2 bit slices per cycle,
- 3 bit slices per cycle,
- and so forth.

And/or **optimize more than one bit slice** (increase complexity).

## An Example of Partial Serialization in Practice

In one generation of Intel processors,

- the designers included **16-bit adders**
- clocked at twice the main clock speed (**6 GHz** instead of **3 GHz**).

These adders could be used to ...

- perform a **single 32-bit add** (two cycles at 6 GHz), **or**
- perform **two 16-bit adds** for multimedia codes.